



Virginia Transportation Research Council Review

Appropriation Act Item 451 4 (2010)

**Report to the Chairmen of House Appropriations and Transportation Committees and
Senate Finance and Transportation Committees**

Virginia Department of Transportation
1401 East Broad Street
Richmond, Virginia 23219

October 2010



VIRGINIA TRANSPORTATION RESEARCH COUNCIL EVALUATION

Presented to:

**Sean T. Connaughton
Secretary of Transportation**

August 13, 2010

**Jonathan Porter, Ph. D., Chief Scientist, Federal Highway Administration
Barbara T. Harder, MBA/TM, Principal, B. T. Harder, Inc.**

VIRGINIA TRANSPORTATION RESEARCH COUNCIL EVALUATION

Contents

Introduction.....3

Scope of VTRC Research Program Evaluation.....4

6 Major Opportunities for Improvement.....5

Evaluation Findings and Conclusions.....12

Program Discussion.....15

Partner Perspectives.....32

Interviews.....33

VIRGINIA TRANSPORTATION RESEARCH COUNCIL EVALUATION

Introduction

Purpose of the Evaluation

The evaluation of the Virginia Transportation Research Council (VTRC) was undertaken to provide an objective assessment of the research program and related activities conducted by the Council.

The effort was performed to review and analyze research management processes and procedures to assess effectiveness and efficiency as VTRC:

- Works with the Virginia Department of Transportation (VDOT) field and operating divisions to develop, implement, and transfer beneficial innovations and improved engineering and technology into agency practice, and
- Provides immediate-response technical assistance and engineering expertise for VDOT field and business units when they encounter construction, maintenance, and operations problems that require a rapid solution and intimate knowledge of VDOT

The evaluation includes perspectives regarding performance of the VTRC compared to selected state Departments of Transportation (DOTs) and national research efforts.

In addition, the evaluation was conducted to identify areas for improvement and opportunities for action which are included in this report.

Furthermore, the evaluation investigated the advantages or disadvantages of transferring activities to other VDOT divisions or outsourcing to universities.

VIRGINIA TRANSPORTATION RESEARCH COUNCIL EVALUATION

Scope of VTRC Research Program Evaluation

Evaluation Objectives:

- ✓ Conduct an objective, independent assessment of the Virginia Transportation Research Council
- ✓ Provide findings that address effectiveness and efficiency of the VTRC research, development, and technology program activities

Evaluation Areas:

- ✓ For effectiveness and efficiencies -- assess funding sources, staffing, and conduct of in-house research; potential for outsourcing materials and engineering research; potential for directing federal grants through Virginia's research universities; and for consolidating policy and planning evaluations into existing VDOT offices

Evaluation Criteria:

- ✓ Expert/Peer Review/Exchange procedures used by the Federal Highway Administration (FHWA)
- ✓ Federal OMB Program Assessment Elements: Relevance, Performance, Quality

Evaluation Process:

- ✓ Comprehensive literature review
- ✓ Interviews and information meetings with state DOTs, FHWA VA Division Office, partners (academic and private sector), VTRC scientists and managers, VDOT (central and field offices); review with VDOT executive management
- ✓ On-site visit, May 10-14, 2010

Reviewers:

- ✓ Jonathan Porter, Ph.D., Chief Scientist, Turner-Fairbank Highway Research Center, FHWA
 - ◆ Federal laboratory quality & management; multi-disciplinary science & technology; civil engineering research & development
- ✓ Barbara T. Harder, MBA/TM, Principal, B. T. Harder, Inc.
 - ◆ State and federal transportation research and technology management; 25 years experience including state DOT research program evaluations

VIRGINIA TRANSPORTATION RESEARCH COUNCIL EVALUATION

Six Major Opportunities for Improvement

The following opportunities for improvement are presented to ensure that practical research results benefit VDOT operations and are monitored for effectiveness:

- Realize more effective **implementation of research results**
- Enhance the **advisory committee process and product**
- Maximize the **value of academic research** capabilities for VDOT
- Renew focus on **communication** of research expertise and implementation successes
- Retain the **collaborative VDOT research business model**
- **Ensure organizational strength** for VTRC through its reporting structure and a scope which is focused solely on research



VIRGINIA TRANSPORTATION RESEARCH COUNCIL EVALUATION

REALIZE MORE EFFECTIVE IMPLEMENTATION OF RESEARCH RESULTS

- Establish a more rigorous implementation process that everyone understands
 - ◆ Add process to the research program manual – formalize and standardize
- Provide greater incentives to jump-start and enable implementation activities
 - ◆ Commit implementation funding specifically for:
 - Pilots and demonstrations of research results
 - Field office application of research products and processes
 - Ensuring technical follow-up after the research is complete to bridge the expertise gap between research and application of new products and processes
 - Developing a Research Advisory Committee (RAC) incentives/award program for successful implementation
 - ◆ Incorporate implementation success as a criterion for advancing on the VTRC career ladder
- Create a dedicated position at VTRC to provide more focus and discipline for implementation of research results
 - ◆ Assist RACs to be more proactive in implementation
 - ◆ Be the go-to person for tools, methods, and techniques to increase implementation success
 - ◆ Provide a closer link between academic research partners and VDOT field offices
- Develop implementation metrics and include them on the research dashboard

ENHANCE THE ADVISORY COMMITTEE PROCESS AND PRODUCT

- Develop RAC operational procedures that are based on best practices and standardize these procedures among all of the RACs
 - ◆ Apply best practices from recent RAC assessment
 - ◆ Gather best practices from other state research advisory processes (e.g., LA, CA, SD)
- Address operational/structural issues for RACs that are struggling in effectiveness (for example, Planning RAC; membership may be too diverse to enable productive consensus)
 - ◆ Develop metrics to determine vitality/effectiveness of RACs
- Increase productivity of RAC meetings through use of trained facilitators
- Use RACs for more than screening potential projects
 - ◆ Problem identification and prioritization (currently the main focus)
 - ◆ Results implementation and deployment support (needs significantly more emphasis)
 - ◆ Communication among VTRC, VDOT, and partners (currently underutilizing the opportunity)
 - ◆ Provide venue for industry and academic partners to be informed about VDOT research activities
- Give RACs some incentive funds to reward participation from the field
- Document changes to the RAC process in the VDOT/VTRC Research Program Manual

VIRGINIA TRANSPORTATION RESEARCH COUNCIL EVALUATION

MAXIMIZE VALUE OF ACADEMIC RESEARCH CAPABILITIES FOR VDOT

- Develop a formalized partnership with Virginia Tech similar to the UVA agreement, and explore potential partnership opportunities with other Virginia research universities with applicable capabilities
- Work to leverage technical expertise within Virginia academic institutions not currently positioned to perform research for VTRC/VDOT
 - ◆ Seek projects that build capacity for applied research for VDOT
 - ◆ Provide incentives for attracting researchers to VDOT problems, e.g., working with national experts, use of VDOT facilities, provision of real-world sites for conducting research
- Augment VTRC staff with personnel funded by university partnerships
- Continue and expand VTRC/academic collaborations that bring national research grant moneys into Virginia
 - ◆ Participate in organizations such as the American Association of State Highway and Transportation Officials (AASHTO) and the Transportation Research Board to be informed of opportunities; scan for project grants and work with academic institutions to pursue promising collaborations

NOTE: Collaborations enable grant awards that won't be won by either VTRC or academia individually (the resulting total is greater than the sum of the individual parts)

- Resume funding of graduate research assistants and incorporate qualified students from a broader spectrum of Virginia institutions rather than only from UVA as done in the past
 - ◆ Enable the assistantship program to be independent of the university's location within Virginia
 - Makes good economic sense for Virginia – builds workforce
 - Provides quality educational opportunities

COMMUNICATE RESEARCH EXPERTISE AND IMPLEMENTATION SUCCESSSES

- Reinstitute the VDOT/VTRC Annual Report, and distribute it widely in hard copy and electronically
- Publish communications regarding VTRC technical expertise, research results, and implementation successes (hard copy and/or electronic)
 - ◆ Publish a periodic e-newsletter to all VDOT employees; also can serve as an information outlet for RACs
 - ◆ Develop implementation success and benefit briefs for distribution to VDOT field offices
 - ◆ Provide news briefs to VDOT public affairs (use strategies from Utah DOT)
- Use academic partnership to augment VTRC staff with communications and marketing professionals to assist VTRC in technology transfer and implementation
- Commit to regular and periodic research results and implementation briefings at executive level staff meetings and District Administrator Council meetings
 - ◆ Take the briefings “on the road” to field offices
- Develop a formal process to increase the opportunities for younger scientists to communicate with VDOT management and technical professionals
 - ◆ Better communications will help tomorrow’s senior researchers be more knowledgeable about VDOT work and will help VDOT field and central office personnel know these younger scientists’ capabilities

VIRGINIA TRANSPORTATION RESEARCH COUNCIL EVALUATION

RETAIN THE COLLABORATIVE VDOT RESEARCH BUSINESS MODEL

- Charge VTRC with enhancing the value of academic contributions to VDOT
 - ◆ Foster practical solutions by academic partners – continue to provide real-world (field) settings and locations for academic researchers' work
 - ◆ Focus academic expertise on VDOT needs
 - ◆ Investigate building new academic research capacity for VDOT through collaborations with universities not currently performing research with VTRC
- Seek opportunities for collaborative research efforts to provide cost-effective quality solutions for VDOT needs
 - ◆ Maintain knowledge of academic expertise available to VTRC
 - ◆ Retain ready access to both in-house scientists and academic researchers
 - ◆ Leverage the ownership and use of research facilities to reduce duplication of cost
- Keep the ability to perform timely and low-cost technical assistance by in-house VDOT employees – the VTRC experts



VIRGINIA TRANSPORTATION RESEARCH COUNCIL EVALUATION

ENSURE ORGANIZATIONAL STRENGTH IN REPORTING STRUCTURE & SCOPE

- Ensure comprehensive department-wide and non-biased services by having VTRC report to a high executive level in VDOT – at the Commissioner or Deputy Commissioner level
 - ◆ Provides broad agency input and perspective for the VTRC to identify and determine near-term and future VDOT needs
 - ◆ Fosters a comprehensive research agenda that responds to agency-wide priorities
- Enable VTRC to focus on its core competencies and functions – research, technical assistance, and analysis and implementation services in conjunction with these research-related activities
 - ◆ Remove the Learning Center from the responsibilities of the VTRC. While VTRC works collaboratively with academic institutions, VTRC core competencies deal with scientific investigation/analysis and one-on-one technical assistance, not large scale training and education. Diverting scientific talent to conduct broad based educational activities has potential to underutilize the scientists and underserve the VDOT personnel who require training professionals. Furthermore, the education and training function is of sufficient scope and impact to VDOT that a stand-alone division reporting to the Chief of Administration may be a more effective organizational option.
 - ◆ Make permanent position appointments to reward staff for work performed and foster management effectiveness and staffing stability and fill current vacant positions
 - ◆ Enable greater flexibility for in-house staffing by augmenting staff as needed through grant funding
 - ◆ Consider filling wage positions to perform technician work; scientists will be more productive by focusing on problems requiring their expertise

VIRGINIA TRANSPORTATION RESEARCH COUNCIL EVALUATION

Evaluation Findings and Conclusions

VALUE TO VDOT AND VIRGINIA

- Compared to other research program models, the **VDOT/VTRC business model of having internal staff along with a balanced outsourcing program with universities is delivering high-value, efficient, quality research.** Reducing the size and scope of the VTRC would have negative impact on the quality/relevance, timeliness, and benefits of evidence-based solutions for VDOT and Virginia.
- **Overall funding levels for research are greater in Virginia than a number of other similar states** because of the VTRC's ability to **win national research grants based on the combination of VTRC and academic technical expertise**; such awards would likely not be received through individual VTRC or individual academic institution efforts.
 - ◆ VTRC has been effective in attracting grant funding, **significantly leveraging VDOT research funding**
 - ◆ VTRC staff has unique capabilities, in concert with its university partners, to **expand grant funding, which is a significant benefit to the Commonwealth**
- **Outsourcing to universities all materials and engineering research would be less effective than what is currently done.**
 - ◆ Significantly increases the difficulty for making research results relevant
 - ◆ Reduces timeliness and quality of solutions
 - ◆ Anecdotal evidence points toward greater cost for solutions received
- **Redirecting all or the majority of federal grants to Virginia universities will reduce overall efficiency and effectiveness of solving immediate and future transportation needs in Virginia.** VTRC is already outsourcing and partnering with universities on approximately 50 percent of all work. Opportunities exist to expand partnerships with universities in order to capture more grant funds and to make the current research program even more productive.
- **Expertise broader than what currently exists would be required for the VDOT central office to handle all non-engineering (soft-science) evaluations.**
 - ◆ Addition to staff or contractors will be necessary
 - ◆ Level of the VTRC expertise now being applied to policy and soft-science problems may not be attracted to an operational office because of the scientific environment in which VTRC operates (potential quality impact)

VIRGINIA TRANSPORTATION RESEARCH COUNCIL EVALUATION

IMPLEMENTATION

- The implementation record is good, yet more can be done.
 - ◆ VDOT has **fully implemented just over 50% of 400+ recommendations** from research over the past five years; another **25% of the recommendations are in the process** of being implemented
 - ◆ Interviews with VDOT staff reveal that implementation can be increased through **funds set aside for "pilot" or incentive programs for the VDOT operating divisions to implement research results**
 - ◆ All state DOTs struggle with implementation; Virginia is among only a handful who even track implementation and the record is good compared to those who measure
 - ◆ VTRC can **likely increase implementation successes by devoting a staff position to provide more focus and discipline** regarding implementation and to work with districts and divisions to promote implementation of research results through pilot and demonstration efforts and other technology transfer vehicles

ORGANIZATION AND ADMINISTRATION

- A strength of the VDOT business model for research: VTRC has always reported to a high level in the organization. Both program content and implementation of research results benefit from this organizational approach. In the event that VDOT undertakes organizational changes, having **VTRC report to the Deputy Commissioner or Commissioner level could enhance implementation of research results and ensure a relevant research program for the future.**
- A recent review submitted to the Commissioner by the Chief of Technology and Research reveals that the implementation of the Blueprint decision to make the **Learning Center part of the Research Council will divert the attention of the Director of Research from the primary research functions.** In addition, that review reveals the education and training function is of sufficient breadth and impact to VDOT to warrant being a stand-alone division, reporting to the Chief of Administration. The VTRC evaluation team agrees and notes there are effectiveness implications for the organizational structure of both VTRC and the Learning Center.
- VTRC is **effective in administering the VDOT research program**; administrative and leadership staff ratio is approximately 15%, which is low when benchmarked against other states with programs of similar size. The average administrative ratio for all state DOTs is 28%. VTRC has robust project development, budget, expenditure management, and project monitoring programs in place, as well as a formal manual, approved by FHWA that it uses to manage the program.
- The VTRC Research Director position has been filled with an interim director for several years. The lack of a permanent director impacts the stability of VTRC, discourages staff prepared to advance, and tends to dampen the innovative culture. The **Director position should be filled.**

VIRGINIA TRANSPORTATION RESEARCH COUNCIL EVALUATION

EXPERTISE AND TECHNICAL ASSISTANCE

- Like other parts of VDOT, VTRC has experienced significant reductions in staff. Nevertheless, the remaining **staff expertise is strong with Ph. D. and P.E. qualifications** covered across multiple subject areas important to the delivery of effective transportation programs. To strengthen the staff even more, **VTRC should expeditiously fill vacant positions when they occur, make greater use of graduate assistantships and faculty/scientists' positions supported by grants, and use wage employees also supported by grants.**
- The VDOT business model of having internal VDOT research staff affords VDOT an **effective and low-cost internal consulting group who can respond to immediate on-call technical assistance and consulting needs for VDOT.** Interviews with executives and management staff at VDOT reveal that VTRC is viewed as the most objective, unbiased technical resource at VDOT. Recently, the WVA Secretary of Transportation sent staff to review VTRC because he wants to put a similar structure in place.

PROBLEM IDENTIFICATION

- The VTRC **research advisory committee (RAC) structure is strong; yet, there are ways to improve** the RACs to enhance problem identification as well as other areas of project selection and implementation.

COMMUNICATION

- Interviews with VDOT managers and executives reveal that VTRC can benefit from **improving communications** on the status of projects and on the importance of recommendations coming from research projects.

ACADEMIC PARTNERSHIPS

- VTRC/Academic partnerships are integral to the work of the Council and important to providing solutions for VDOT problems. This role is described in many of the findings and conclusions above. **Participation of universities in partnership with VTRC allows greater benefit than either partner could accomplish on its own.**

Overall, the VDOT business model for research is strong and VTRC is a vital and valuable asset for VDOT; there are opportunities for improvement in the following areas:

- ◆ Implementation
- ◆ Advisory Committees
- ◆ Stronger and expanded university partnerships
- ◆ Communication
- ◆ Organization

Program Discussion

- State DOT Research Programs
 - ◆ Federal Mandate for Research
 - ◆ Program Models
- VDOT/VTRC Program
 - ◆ Program Synopsis
 - ◆ Organizational Structure and Scope
 - ◆ Technical Capacity
 - ◆ Efficient Administrative Staffing
 - ◆ Research Expenditures by Source
 - ◆ Contract Expenditures
 - ◆ Awards & Expenditures of Grants
 - ◆ Benefits and Value and Benefits Examples
 - ◆ Conduct of Research
 - ◆ Technical Assistance, Special Studies, and Analysis
 - ◆ Research Advisory Committees
 - ◆ Engagement of Universities
 - ◆ Implementation of Research Results

VIRGINIA TRANSPORTATION RESEARCH COUNCIL EVALUATION

State DOT Research Programs

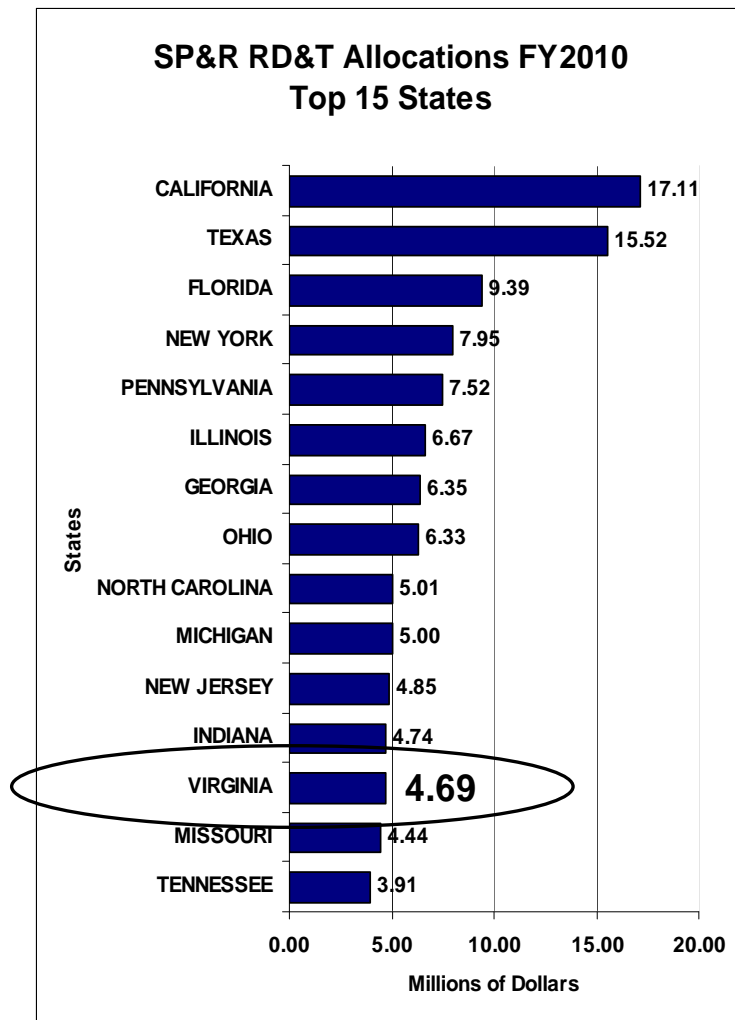

Federal Mandate for Research -- State Planning and Research (SP&R)

- 2% of apportionments from Interstate Maintenance, NHS, Surface Transportation, Highway Bridge, and Congestion Mitigation, Equity Bonus
- States must allocate .25% of SP&R funds for research, development, and technology (RD&T)
- Allocations to VDOT are 13th among the state SP&R grant amounts with VDOT research providing practical, quality solutions – while not receiving the largest SP&R amounts, VDOT does research of national significance while addressing Virginia needs

Models used by states for RD&T Programs

- 3 Models in use
 - ◆ Fully outsourced to academia
 - Very few and usually small programs and KY and WI
 - ◆ Fully contract program (PA, FL, NJ)
 - With private sector, academia, and others
 - ◆ Combination of in-house and outsourced
 - Examples LA, NY, SD, IN
 - VDOT uses this model
- The larger the program and more comprehensive it's mission, the higher in the organization it needs to report; broad based programs => to the executive level
- Smaller programs or solely contract programs may be located in planning offices – reflecting the SP&R funding source, or within engineering technical offices reflecting association with materials testing and evaluation responsibilities. (Organizational location generally shapes research focus.)

VIRGINIA TRANSPORTATION RESEARCH COUNCIL EVALUATION

VDOT/VTRC Program Synopsis

Core Functions

“We promote excellence in transportation through objective research and superior technical services.”

- ✓ Applied research solving VDOT needs
 - In-house
 - University collaboration and oversight
- ✓ Applied research for over-the-horizon needs
- ✓ Technical assistance
- ✓ Legislative studies
- ✓ Implementation support



VTRC provides a substantially broader range of services to VDOT than most state research programs provide to their agencies: in-house knowledge, technical assistance, and leveraging of expertise and facilities with partners.

Program Stats

- ✓ 125-140 active projects in pipeline
- ✓ FY 2009 expenditures \$11.18M
- ✓ Complete 45-50 projects each year
- ✓ 28 grants, FY 2009
- ✓ Citations - Most VTRC scientists' work is regularly cited; some hundreds of times

Research Areas

- ✓ Materials Science
 - High-performance, self-consolidating concrete
 - Warm-mix asphalt; stone-matrix asphalt
 - “Premium pavements”, quiet pavements
 - Rapid repair techniques and technology
- ✓ Structures, Pavement, and Geotechnical Engineering
 - Extending service life of bridges, roads
 - Pavement infrastructure
 - Long-Term Bridge Performance Program
- ✓ Environment, Planning, and Economics
 - Preserving natural, cultural resources
 - Land use and transportation
 - Special studies; fees for overweight trucks, Area HQs
- ✓ Safety, Operations, and Traffic Engineering
 - Improving mobility and safety
 - IntelliDrive (VII), hurricane evacuation
 - Wet night time markings and visibility

The diversity of VTRC research areas successfully address the variety of VDOT needs. VTRC must have sufficient flexibility in staffing to add technical expertise when required by VDOT.

VIRGINIA TRANSPORTATION RESEARCH COUNCIL EVALUATION

VTRC Organizational Structure and Scope

- The high executive level location of the VTRC in the organizational structure adds value to solutions for VDOT and Virginia
 - ◆ Enables department-wide input to identify/develop VDOT needs
 - ◆ Increases relevancy of VTRC work -- informed by executive level perspective
 - ◆ Allows non-biased technical and policy solutions for executive level decision making
- **VTRC should continue to report at a high executive level in VDOT – to the Commissioner or Chief Deputy Commissioner level**
- Several permanent management positions remain as acting assignments (Research Director in particular); **attention to filling these positions** will make the VTRC organization more effective and efficient. In addition, when positions are vacant, filling them expeditiously increases effectiveness
- The organizational model VTRC uses has been adopted by other states, e.g., LA DOTD, and recently a West Virginia DOT senior executive and research manager visited VTRC to learn how WVA can replicate the VTRC. Keep the model currently used.
- VTRC has a unique set of core competencies and functions: research, technical assistance, and analysis and implementation services in conjunction with research
 - ◆ The Learning Center responsibilities of the VTRC are not as closely aligned with the VTRC core competencies as was thought at an earlier time.
 - ◆ Diverting scientific talent to conduct broad based educational activities has potential to underutilize the scientists and underserve VDOT both for 1) provision of research solutions and 2) supply of training professionals for education of VDOT personnel
 - ◆ The education and training function of the **Learning Center is of sufficient scope and impact to VDOT that a stand-alone division reporting to the Chief of Administration** may be a more effective organizational option.

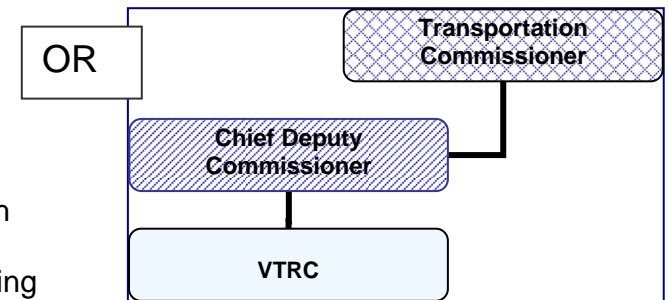
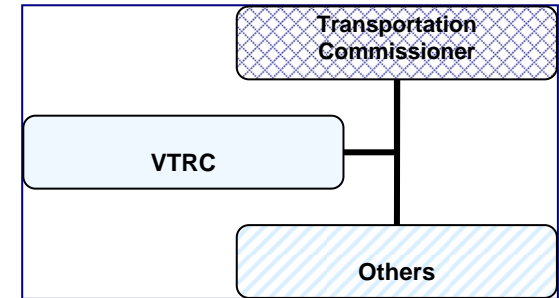

VIRGINIA TRANSPORTATION RESEARCH COUNCIL EVALUATION

VDOT/VTRC Technical Capacity

- **Technical staff is fully committed to technical activities**
 - ◆ 25-30% of scientist's time is dedicated to on-call technical assistance – in support of rapid turnaround usable solutions for VDOT central and field offices
- Challenging assignments, solutions that are implemented, and management that empowers intellectual excellence translates to an environment for nurturing world-class expertise – **VTRC draws excellent talent**
- **Contracted expertise** -- VTRC leverages available expertise -- VTRC has existing mechanisms for contracting with selected academic institutions in VA and public sector institutions throughout the nation
- VTRC staff decreases since FY2006 of 47% overall including 27% of scientists eroded all aspects of services provided. These staff reductions have added technician level work to the scientists' efforts, reducing some amount of professional work. **Adding wage level (technician) positions will increase efficiency of the VTRC.** Further staff decreases will especially impact VTRC's ability to provide timely technical assistance in sufficient capacity and will decrease the potential to leverage expertise with partners as they seek to bring in grants to Virginia.
- **In-house, as-needed expertise** – currently VTRC can not add in-house staff through bringing in researchers funded by grants. VTRC should have additional flexibility for staff augmentations funded by grants so that specific expertise is available when required.

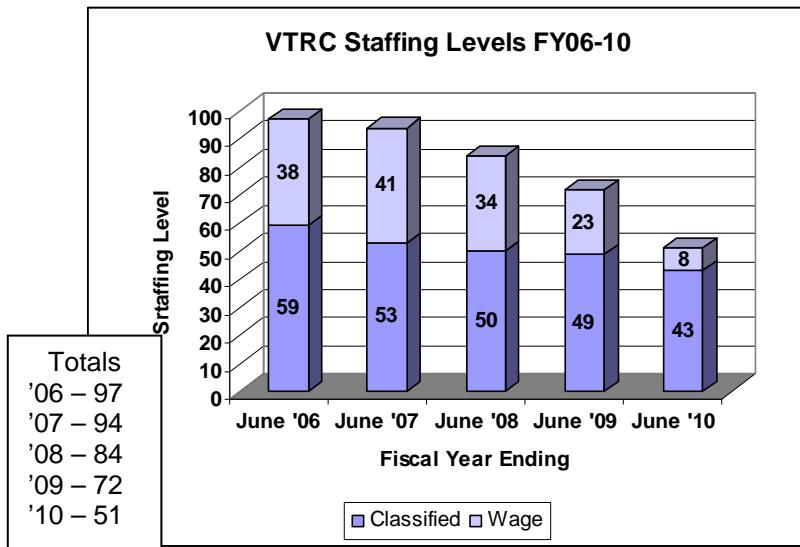

VTRC TECHNICAL STAFF			
Technical Area	Ph.D	P.E.	Masters
Environment, Planning, and Economics	2	2	7
Materials	3	6	4
Safety, Operations, and Traffic Engineering	1	3	5
Structures, Pavement, and Geotechnical Engineering	4	6	1

VIRGINIA TRANSPORTATION RESEARCH COUNCIL EVALUATION

VDOT/VTRC Efficient Administrative Staffing

“Sufficiently Lean”

- Survey of 47 state DOT research programs (AASHTO Research Advisory Committee)

CATE-GORY	AVG # OF TECHNICAL STAFF	MIN	MAX	AVG # OF ADMIN STAFF	MIN	MAX	RATIO ADMIN/ TECHNICAL
LARGE	19.2	0	55	5.2	1	11	.27
MID	11.7	1	37	3	1	10	.26
SMALL	3	1	9	1.3	0	3	.43
ALL	11.7	0	55	3.3	0	11	.28

Total program size in year 2000; Large over \$5M, Mid \$1.5 to 5M, Small up to \$1.5M
Virginia = large program, .20 ratio at the time

- **Current ratio = .15**
34 filled technical positions; 5 leadership & business office = .15 (not incl. 4 unfilled positions)
- **Maintain this lean ratio**

VIRGINIA TRANSPORTATION RESEARCH COUNCIL EVALUATION

VDOT/VTRC Research Expenditures by Source

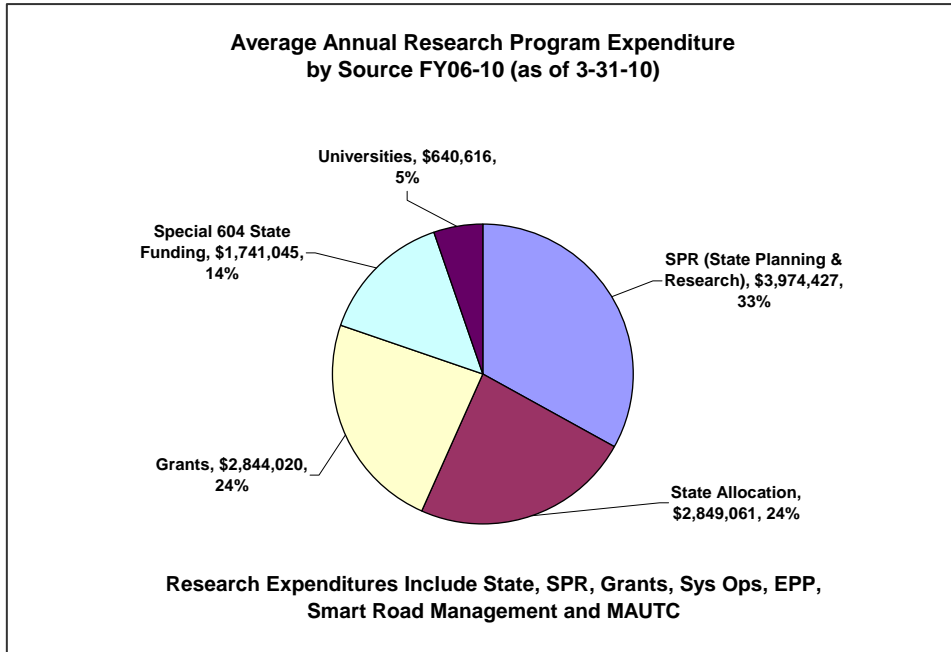

- **Good balance** among state funds, federal-aid SP&R funds and grants funding usage – keep this diversity; particularly enables leveraging of state moneys
- Expenditures of grant funds vary with numbers and amounts of awards; there is **existing capacity to handle more**

Average Annual Total Research Expenditures Past 5 Yr.

- Total Annual Average \$12.049 M
- Includes: State, SP&R, Grants, Sys Ops, Environmental Protection Plans (EPP), Smart Road, Mid-Atlantic University Transportation Center (MAUTC), and administration
- Does not include funds from VDOT divisions

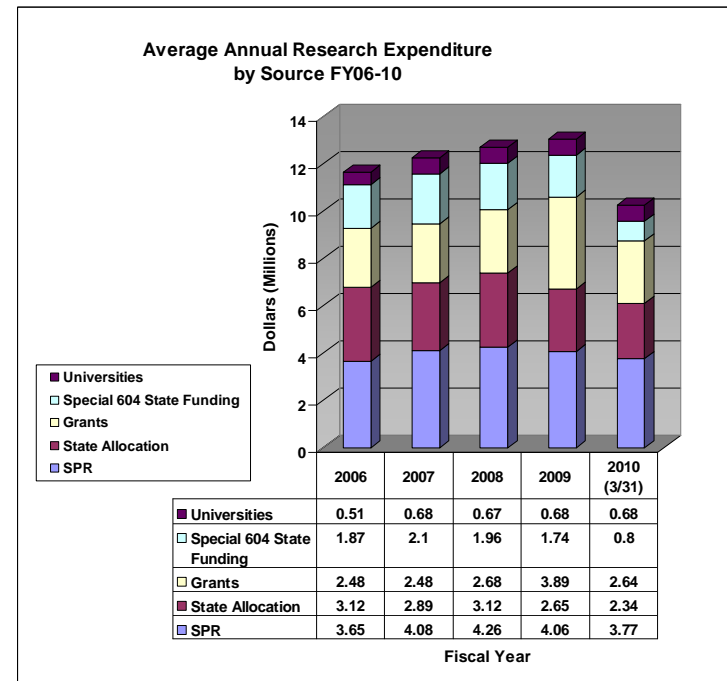

VIRGINIA TRANSPORTATION RESEARCH COUNCIL EVALUATION

VDOT/VTRC Contract Expenditures

- In the past 5 years, contract expenditures totaled \$22.12 M
 - ◆ \$15.17 M -- Virginia Tech
 - ◆ \$5.45 M -- University of Virginia
 - ◆ \$1.5 M -- Others

- Annual percent of whole ranges for VA Universities
 - ◆ VT/VTTI: 64-77%
 - ◆ UVA: 20-29%
 - ◆ Old Dominion: 0-2%
 - ◆ Hampton: 0-1%
 - ◆ William & Mary: 0-1%

- **Contract expenditures are governed by type of research required, facilities at the institution, and specific expertise available**

- ◆ Amount of structures and other research at Virginia Tech shows a formalized partnership agreement would be beneficial
 - Virginia Tech is leveraging its expertise and facilities well, to the benefit of VDOT
- ◆ Other research universities in Virginia can provide expertise for solving VDOT problems; relationships must be developed and are best done through well-chosen research collaborations. VTRC will have to make concerted effort to grow these relationships, some in niche areas where solutions are required relatively infrequently

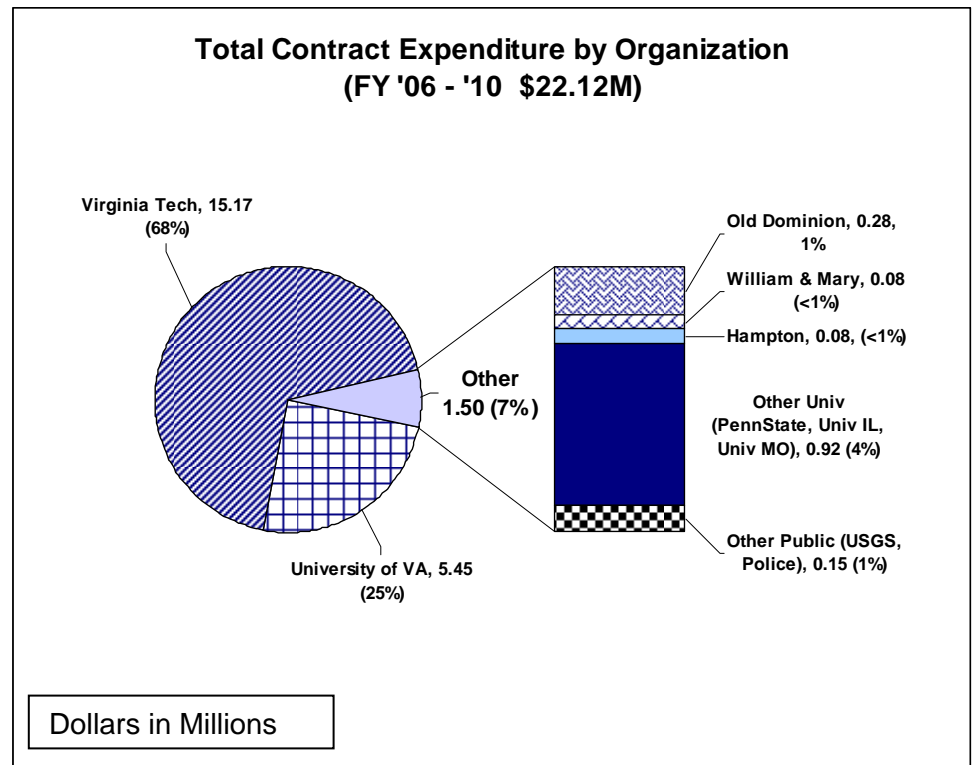

VIRGINIA TRANSPORTATION RESEARCH COUNCIL EVALUATION

VDOT/VTRC Awards & Expenditures of Grants

Nearly $\frac{3}{4}$ of new grant expenditures (\$11.82 M) during the past 5 years went to universities. Very good balance – shows high leveraging of resources

Snapshot of current grants extending through 4/2015

- 17 active grants; \$12.86 M budgeted, \$5 M balance
- Of the past 25 grants, all grant moneys are scheduled to be fully expended with the exception of 1 funded project to Virginia Tech
- Grant source examples
 - ◆ Innovative Bridge Funds
 - ◆ SP&R Pooled Fund Study
 - ◆ Federal earmark; legislation
 - ◆ FHWA, FMCSA
- Project topic examples
 - ◆ Long-term bridge performance
 - ◆ Smart Road
 - ◆ Innovative concrete – high performance, lightweight, self-consolidating
- VTRC and its academic partners have a unique opportunity to pursue grants for Virginia's economic advantage as the collaborations solve transportation problems – a win-win activity. Scanning for opportunities to work with existing partners and looking for research that fosters the relationship with new academic partners will be necessary to maintain or increase the grant levels.

**New Grants Expenditures
(FY '06 - '10 Total \$15.9 M)**

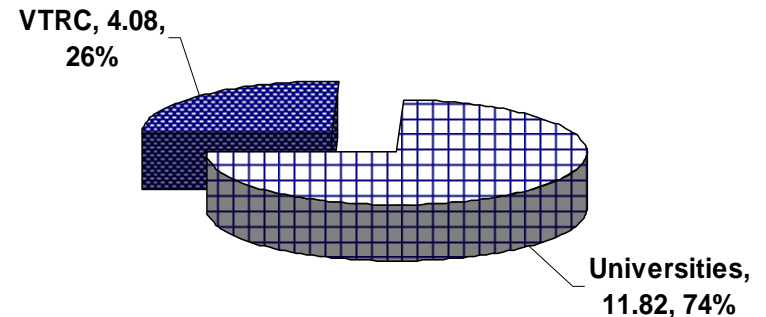

To receive this level of grants, collaboration between VTRC and its academic partners is essential.

Grants are awarded due to the unique technical competence of the collaboration. It is likely for most of these projects that individual organizations would not have received the award and these grant funds would not have been brought into Virginia.

VIRGINIA TRANSPORTATION RESEARCH COUNCIL EVALUATION

VDOT/VTRC Benefits and Value

- **Highly positive user and partner testimony**
- Citations and use of research results
 - ◆ Good implementation rate in Virginia
 - ◆ Virginia solutions are very much on target that the national agenda is served – VDOT/VTRC work is known and used nationally and internationally
- **VDOT/VTRC research model has been used in a variety of states** – most recently a WVA executive and research manager visited VTRC to learn how to set up a research program in that state
- Meet Federal OMB Criteria
 - ◆ Relevant research and technical assistance – VTRC scientists are VDOT employees – they “know the territory” and are researching the right items -- not every project is or should be a winner
 - ◆ Quality: intellectually stimulating environment and challenging needs fosters top-level expertise – recognized nationally and internationally
 - ◆ Performance: services comprising solutions to short term (technical assistance) and more longer-term needs
- Quantitative benefits are always hard to calculate; every state DOT research group has difficulty with this issue; no standard exists among state research activities. Based on the methodology in the VTRC Research Program Manual, VDOT/VTRC **calculated average annual dollar benefits from FY2006-FY2009:**
 - ◆ \$39.4M for a 1 year return period
 - ◆ \$194.5M for a 5 year return period

VIRGINIA TRANSPORTATION RESEARCH COUNCIL EVALUATION

VDOT/VTRC Benefits Examples

Technical assistance efforts for the I-95 James River Bridge deck rehabilitation allowed reuse of beams that saved VDOT \$3 M.



VTRC evaluated lightweight high performance concrete (LWHPC) in two bridges on Route 33, Virginia. These concretes are expected to be durable and cost-effective. The initial cost of LWHPC is higher than the conventional HPC concrete, but the reduced weight of the lightweight concrete will result in longer spans, smaller piers (or less of them), reduced substructure requirements, and easier transportation and erection of elements, leading to substantial savings. The study recommended that LWHPC continue to be used for beams and decks and possibly for accelerated construction with precast units for rehabilitation projects. Savings in the millions will be realized given that VDOT spent an average of \$10.68 million per year on prestressed concrete beams in fiscal years 2003 through 2008.

The Highway Safety Corridor (HSC) program allows VDOT to designate high-crash locations on the interstates and primary system for increased fines, with concurrence from DMV and State Police. The research project developed the process that is currently in use by VDOT to designate HSCs. The implementation of this process resulted in three interstate HSCs which are still in place. Increased enforcement, low cost engineering countermeasures, and driver education have been used to improve safety at these locations. Analysis from Fall 2009 shows that the I-81 HSC has experienced a statistically significant 12% reduction in crashes following HSC implementation.

Virginia (VDOT) continues to make effective and statewide use of premium asphalt concrete mixtures even when initial costs for these mixtures can be comparatively high. VTRC research provided necessary analysis procedures and performance data to permit pavement engineers to match mix type and expected service requirements. This research documents \$15 million in annual savings through selection and use of proper materials.

VDOT's safety service patrol (SSP) in Hampton Roads provides a nearly five-to-one benefit compared with what VDOT pays to provide this service. During the one-year study period, VDOT spent \$2.35 M on the SSP and recouped an \$11.08 M benefit. (Annual Report 2007)

"A handful of projects we completed in 2005 can be easily quantified; the total annual benefit is conservatively estimated at approximately \$19 M. These nine research projects more than pay for the entire research program and provide a return to VDOT of nearly 50 percent in terms of the cost of the program....when fully implemented, will account for almost \$100 million in returns over a five-year period." (Annual Report 2005)

VIRGINIA TRANSPORTATION RESEARCH COUNCIL EVALUATION

VDOT/VTRC Conduct of Research

- Leveraged network of **research facilities** provides cost-effective experimental capabilities to VDOT, academia and others
 - ◆ Materials Laboratories at VTRC; university laboratories; The State Highway System
 - ◆ VA Smart Road – VDOT ownership, Virginia Tech Transportation Institute partners with VTRC to manage facility and conduct research; use also by industry and other states
 - Naturalistic driving study/driving behavior
 - Visibility research
 - Pavement surface characteristics
- VTRC **research addresses longer-term issues** for VDOT
 - ◆ For example, corrosion resistant rebar – research record proved life-cycle cost benefits to support policy changes



- **Implementation** of research results is the goal
 - ◆ VDOT champion engaged at project initiation and throughout research
 - ◆ Ensure problem scope is relevant
 - ◆ Begin to plan for implementation early
 - ◆ Project review at closeout to discuss results and recommendations for implementation -- more focus on implementation should be done, RACs can play a larger role in implementation
- **Efficient administrative management:** VTRC small business staff manages cost, schedule, and performance tracking for research projects

VDOT/VTRC Research Examples

Experimental and Analytical Investigation of Full-Depth Precast Deck Panels on Prestressed I-Girders
-- as a result of this research:

- Full-depth, precast concrete bridge deck panels can be used in lieu of traditional cast-in-place bridge deck construction to reduce bridge closure time and relieve construction related traffic delays and congestion.
- A full-scale bridge structure incorporating full-depth deck panels was constructed and tested at the Virginia Tech Structures Lab. Design details were documented and recommendations made to the Structure and Bridge Division. A bridge structure was identified in the Bristol District to use full-depth precast panels. The bridge design, incorporating recommendations from this study, is near completion and will be ready for a Fall 2010 advertisement date.



Recycling of salt-contaminated stormwater runoff for brine production

- VTRC conducted extensive field and lab experiments to develop specific recommendations to reduce the over 60 million gallons of salt-contaminated stormwater collected annually. The research resulted in specific practices and designs for reducing the volume of waste. When fully implemented, these practices should decrease the collection of salt-laden stormwater by nearly 50 percent.
- Re-using the captured stormwater for pre-wetting and direct brine application in advance of winter storms was deemed to be both technically feasible and cost effective. Proper management and re-use of the stormwater runoff to create brine will not only result in significant annual savings, \$1 million to \$6 million, depending on winter snow/ice amounts; roadway chloride loading will be greatly reduced, up to 35 percent; fewer freshwater resources will be needed for anti-icing; and the potential for offsite contamination of ground and surface water will be decreased.

VIRGINIA TRANSPORTATION RESEARCH COUNCIL EVALUATION

VDOT/VTRC Technical Assistance, Special Studies, Analysis, & Reference

➤ Technical Assistance

- ◆ In-house technical expertise provides value
 - Timely answers for VDOT
 - No additional cost to field or central office
 - Technical expertise *and* intimate knowledge of VDOT
- ◆ VDOT professional networks provide ready access to VTRC expertise
 - Staff know “who to call” at the leadership and working level

➤ Technical Assistance examples

- ◆ I-95 James River Bridge deck rehab – re-use of beams
- ◆ I-81 Cantilever Sign
- ◆ I-81 Bridge Deck Failure
- ◆ Varina-Enon Bridge
- ◆ Methods to Evaluate Benefits of Safety Service Patrol Programs
- ◆ Highway Safety Corridor Analysis

➤ VTRC provides **responsive and objective analysis** of critical issues for VDOT

➤ VTRC **conducts studies** for VDOT and the General Assembly

- ◆ Overweight vehicles and permit fees
- ◆ Highway noise reduction – quiet pavements
- ◆ Rest-area privatization
- ◆ Mileage-based fees

➤ VDOT library provides **comprehensive reference for scientists/engineers** and is a leader among state DOTs

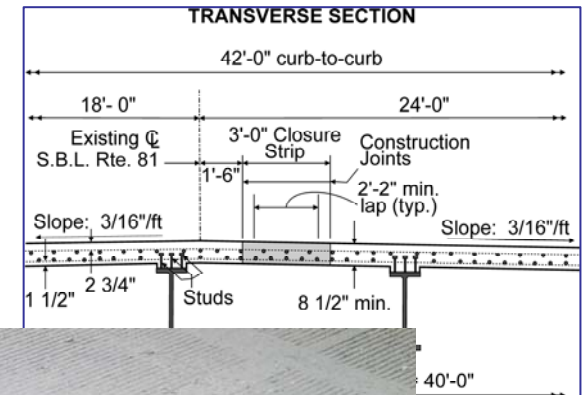

VIRGINIA TRANSPORTATION RESEARCH COUNCIL EVALUATION

VDOT/VTRC Research Advisory Committees (RACs)

- RACs vet and prioritize problems
 - ◆ Problem statements commonly originate from VDOT central office, field staff, university researchers, VTRC scientists
- Process works in most technical areas, less so in some (for example, Planning RAC lack of productive operations, membership potentially too diverse)
 - ◆ VTRC is aware of variability of effectiveness -- additional productivity for meetings is needed; e.g., a subgroup of targeted technical experts on RACs could assist in refining problem statements for consideration by full RAC
 - ◆ VTRC recently conducted a RAC Assessment – there are opportunities for process improvement in its implementation recommendations
- RAC formal membership primarily VDOT employees; academia and industry representatives welcome to attend meetings
 - ◆ RACs provide essential field practice input to research project selection
 - ◆ Keeps department focus yet fosters input from others
- Need for **standardization of processes using best practices** from other states' experiences
 - ◆ Many state DOT research programs have RACs
 - ◆ Retain flexibility to foster dynamic character of each RAC
- Conduit for cross department communication is not formalized as a function of the committees
- RACs have not played a sufficiently significant role for implementation of research results

- **RACs can be more effective by:**
 - ◆ Developing and following consistent operational processes, informed by best practices
 - ◆ Providing more substantive vetting of implementation plans; providing greater number of champions for fostering implementation, being a resource to identify pilot and demonstration sites/projects, providing incentives for implementation
 - ◆ Being a primary communication venue among the operational and field staff and the VTRC scientists and their partners
 - ◆ Encouraging greater information sharing among VTRC and its industry partners and universities with which it is developing relationships

Research Advisory Committees

Asphalt
Bridge
Concrete
Environmental
Geotechnical
Pavement
System Operation
Traffic & Safety
Transportation Planning

VIRGINIA TRANSPORTATION RESEARCH COUNCIL EVALUATION

VDOT/VTRC Engagement of Universities

➤ University partners and collaborations

- ◆ Virginia Universities
 - University of Virginia
 - Virginia Tech
 - Old Dominion University
 - Hampton University
 - College of William & Mary
- ◆ Universities outside of VA
 - University of Illinois, Penn State (Mid-Atlantic University Transportation Center), University of Missouri, Rutgers, and others

VDOT/VTRC Scientists and Engineers are viewed by universities as collaborators and partners; essential for the quality and quantity of transportation research done in Virginia

➤ Effective leverage of university expertise (faculty, researcher, and student) for:

- ◆ Program guidance (RAC participation)
- ◆ Conduct of research and some technical assistance
- ◆ Collaboration for competitive grants
- ◆ Balance VDOT practical needs with academic agenda (research & education)
- ◆ Cost-effective access to broader range of expertise as needed
- ◆ Partnerships, the key to securing additional grants

➤ Partnership example: VTRC, VT, and Rutgers partnership on Long Term Bridge Program (LTBP) benefits Virginia and the national agenda

➤ Economic advantage for Virginia: VTRC provides relevant, real world (field) research opportunities and experiences for developing future transportation professionals

➤ Funding for Graduate Research Assistantships was discontinued due to lack of funding; this program should be reinstated

➤ An effort to develop expertise at research universities not currently partners with VDOT/VTRC can bring additional talent to solving VDOT needs; VTRC should consider efforts to **increase engagement** of these institutions; VTRC: foster network of academics, scan for opportunities that foster the relationship, build capacity through project work

University contracts:
76-- FY 2009
63 -- FY 2010

of those contracts:

FY 2009: UVA 33, VT 37
FY 2010: UVA 30, VT 27

Universities awarded
nearly $\frac{3}{4}$ of all new grants
in past 5 years

Over \$22 M in contract
awards during the past 5
years

VIRGINIA TRANSPORTATION RESEARCH COUNCIL EVALUATION

VDOT/VTRC Implementation of Research Results

Are results implemented?

- **Over 50% of all projects are fully implemented and nearly 75% have some significant degree of implementation**
- Research project implementation is good – one comparable state DOT program = 62%
- Technical assistance is implementation = ~ 25% of VTRC scientist/technical staff time for implementable solutions for VDOT central and field office personnel
- **While record is good, more can be done** to communicate research results successes and provide incentives for field offices to try something new
 - ◆ There is not sufficient emphasis made to promote participation in pilots and demonstrations as well as further development of research products
- No **specific implementation funds** exist to bridge the gap between research result and applicable product or process; particularly important for research results from external to VDOT academic efforts.
- Creating a **VTRC staff position committed to implementation** would provide the expertise to encourage more effective practical application of research results throughout the department

Completed Projects by Functional Areas FY06-FY10

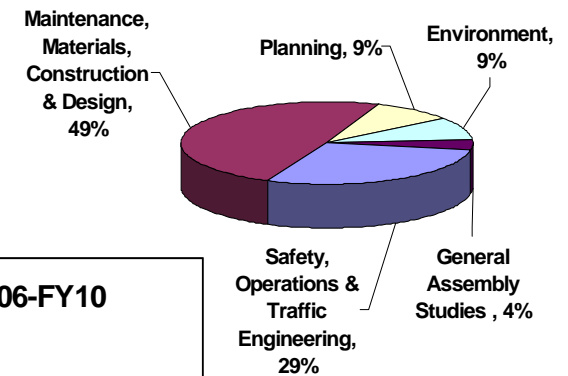

Status of Recommendations FY06-FY10
446 Total Projects

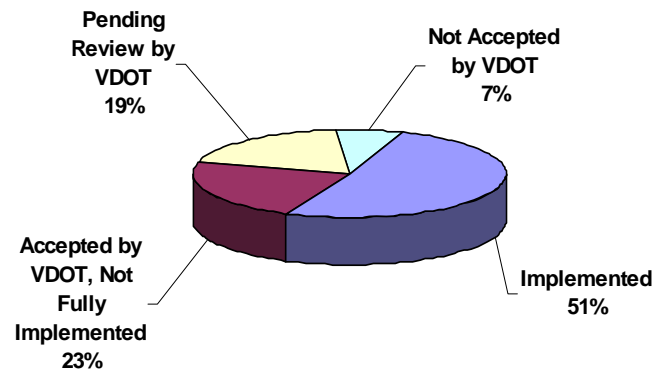

VDOT/VTRC Partner Perspectives

Comments from personal and telephone interviews

From External Partners:

- University transportation research programs are stronger as a result of VTRC
- VTRC provides students relevant research opportunities and experiences
- VTRC is a true partner, not merely a funding source
- VTRC partnership is critical to securing competitive funds
- VTRC processes need to be more transparent
- Continue focusing on strong working relationship between VTRC and the Materials Division

From Internal VDOT Partners:

- Depend on VTRC for response to field failures/issues
- The most analytical and objective part of VDOT
- Very customer oriented
- Get a better product from universities when VTRC is involved
- VTRC is essential to the success of VDOT
- Need a structured, unified, measured approach to implementation
- Need to better communicate the research program within VDOT

VIRGINIA TRANSPORTATION RESEARCH COUNCIL EVALUATION

Interviews

In the course of the evaluation, interviews and information gathering meetings were conducted in person or by telephone with department officials, VTRC leadership team and scientists, and external partners.

VDOT

- Gary Allen – Chief, Technology, Research, and Innovation
- Andy Babish – State Materials Engineer
- Rob Cary – Lynchburg District Administrator
- Richard Caywood – Salem District Administrator
- Steve Long – Environmental Division Administrator
- Mal Kerley – Chief Engineer
- Keith Martin – Policy Division Administrator
- Robbie Prezioso – State Maintenance Engineer
- Connie Sorrell – Chief, System Operations
- Ken Walus – State Structure and Bridge Engineer
- Rick Walton – Chief, Planning and Environment
- Greg Whirley – Commissioner

VTRC and Center for Knowledge and Information Transfer

- Mike Brown – Research Scientist, Structures, Pavements, and Geotechnical Engineering
- Katherine Clark – Center for Knowledge and Information Transfer
- Donna Cognata – Business Manager
- Brian Diefenderfer – Research Scientist, Structures, Pavements, and Geotechnical Engineering
- Mike Fitch – Associate Principle Research Scientist, Environment, Planning, and Economics
- Mike Fontaine – Senior Research Scientist, Safety, Operations, and Traffic Engineering
- Maureen Hammer – Center for Knowledge and Information Transfer
- Jose Gomez – Associate Director, Structures, Pavements, and Geotechnical Engineering
- Cathy McGhee – Acting Associate Director, Safety, Operations, and Traffic Engineering
- Amy O’Leary – Associate Director, Environment, Planning, and Economics
- Michael Perfater – Acting Director of Research Operations
- Steve Sharp – Research Scientist, Materials Research
- Michael Sprinkel – Associate Director, Center for Materials Research

VIRGINIA TRANSPORTATION RESEARCH COUNCIL EVALUATION

Interviews (continued)

External Partners

- Federal Highway Administration
 - ◆ Irene Rico – Virginia Division Administrator
 - ◆ Lorenzo Casanova – Programs and Technology Engineer, Virginia Division
- George Mason University
 - ◆ Jonathan Gifford – Dean School of Public Policy, Associate Dean for Research, Transportation Policy, Operations, and Logistics
- Hampton University
 - ◆ Devendra Parmar – Professor, Electrical Engineering, School of Engineering and Technology
- Old Dominion University
 - ◆ Asad Khattak, Professor, Civil & Environmental Engineering Department
- University of Virginia
 - ◆ Mike Demetsky – Chair, Civil and Environmental Engineering
 - ◆ Brian Smith – Professor, Civil and Environmental Engineering
- Virginia Tech
 - ◆ Thomas Cousins – Professor, Civil and Environmental Engineering
 - ◆ Tom Dingus – Professor and Director, Virginia Tech Transportation Institute
 - ◆ Sam Easterling – Department Chair, Civil and Environmental Engineering
- American Concrete Pavement Association, Mid-Atlantic Chapter
 - ◆ Robert Long – Executive Director
- Virginia Asphalt Association
 - ◆ Richard Schreck, Executive Vice President
- Virginia Transportation Construction Alliance
 - ◆ Jeffrey Southard, Executive Vice President